

20 ORIGINALNÍ NÁVOD 2/3 Pravidla pro instalaci a použití
ORIGINAL INSTRUCTIONS 2/3 Installation and user manual
19 MANUEL ORIGINAL 2/3 Règles de montage et d'utilisation
18 INSTRUKCJA ORYGINALNA 2/3 Zasady montażu i użytkowania

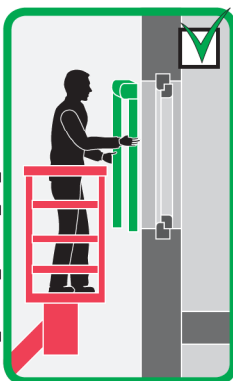

VMZ ZIP

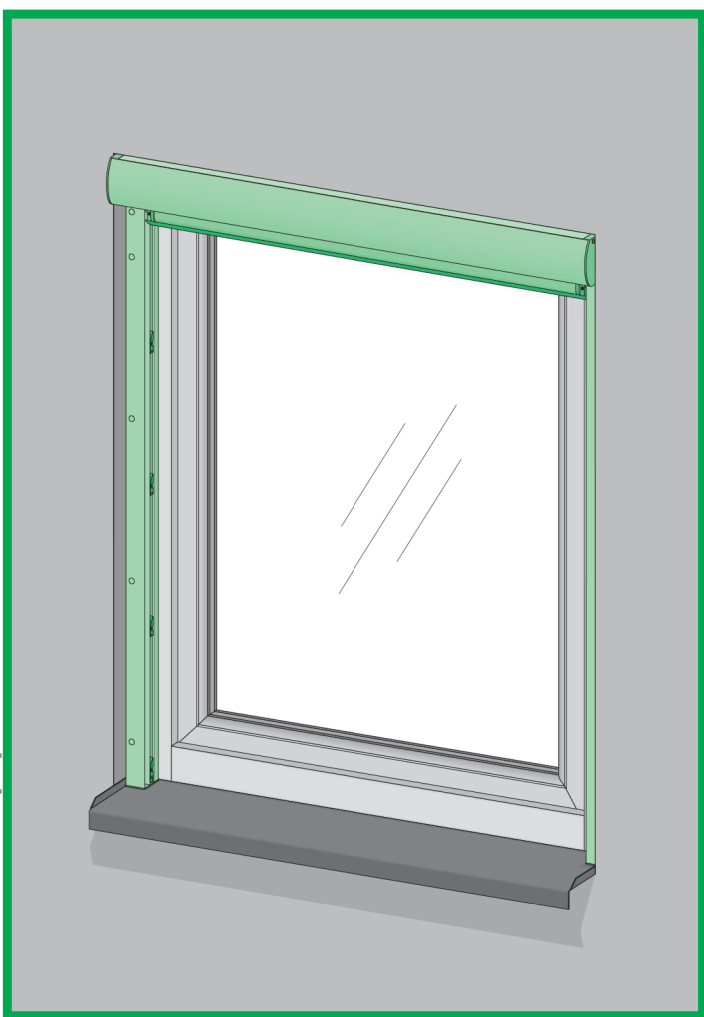

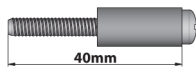
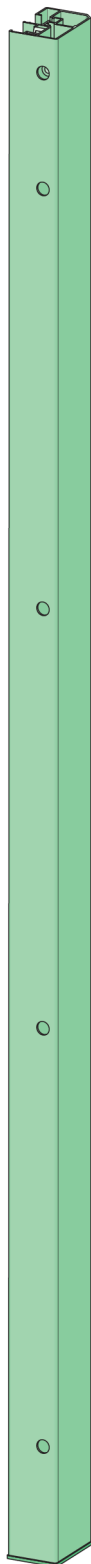
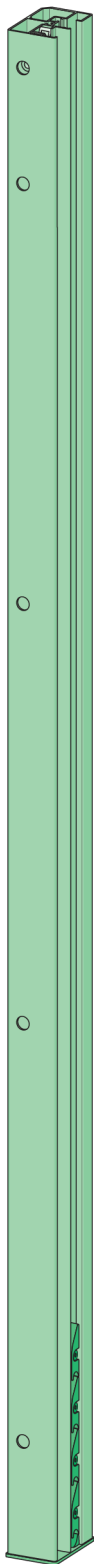
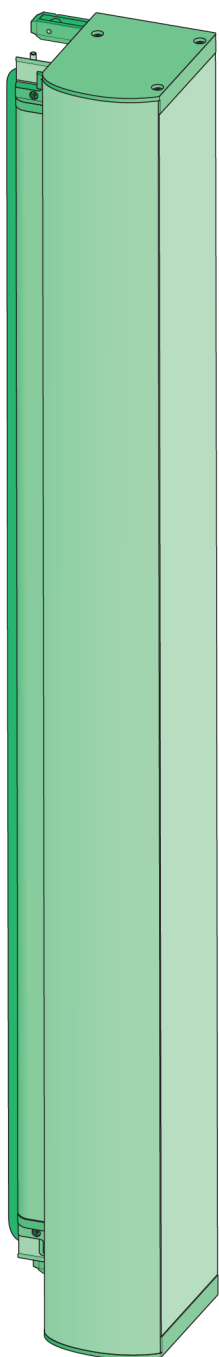

1

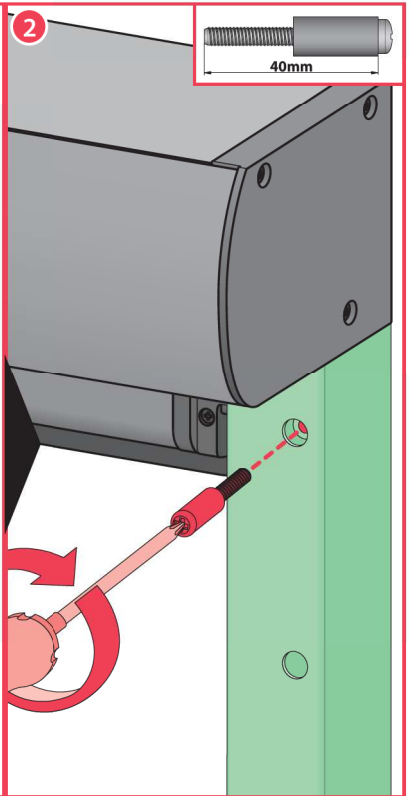
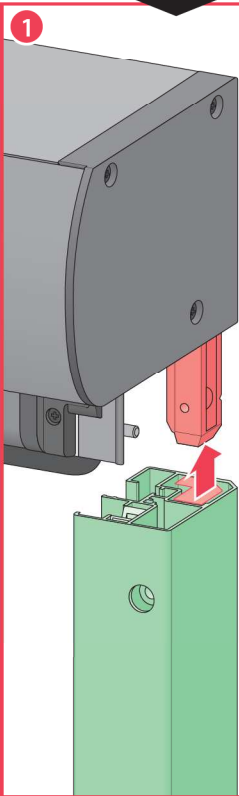
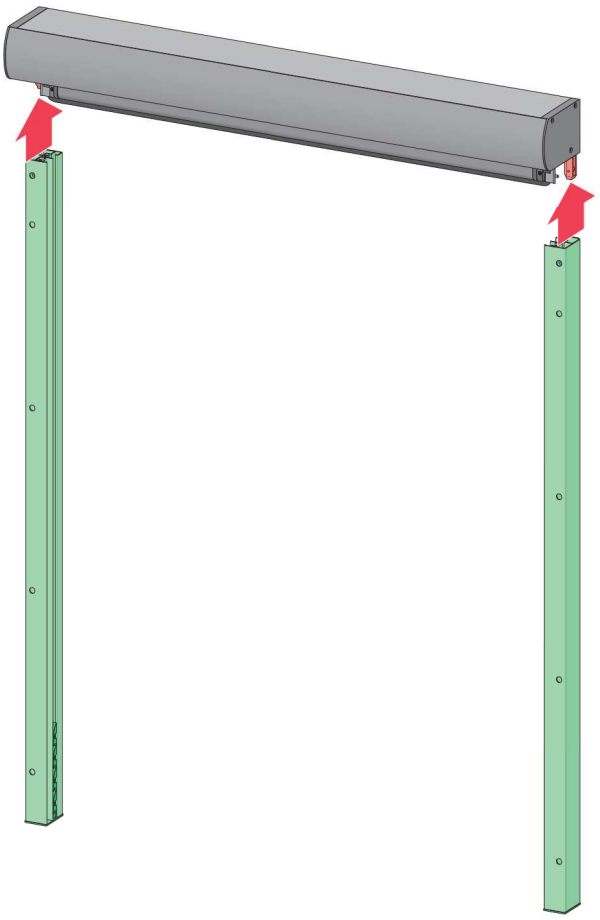

3

2a

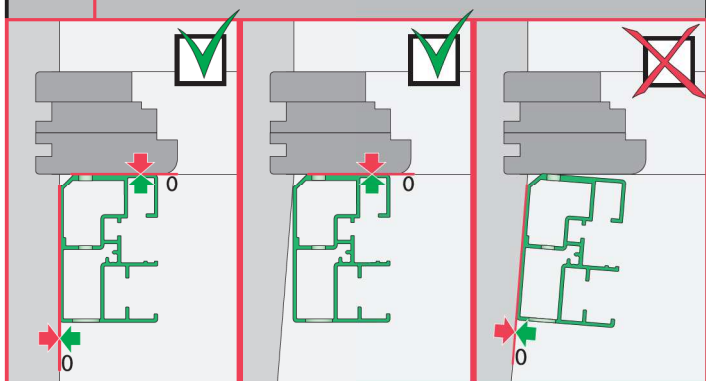
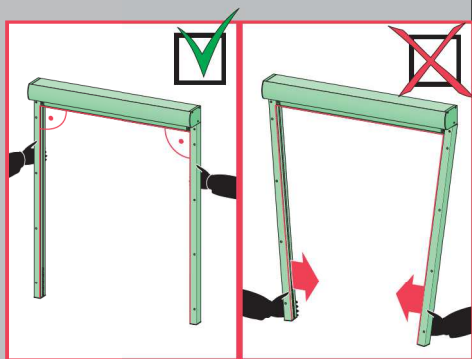
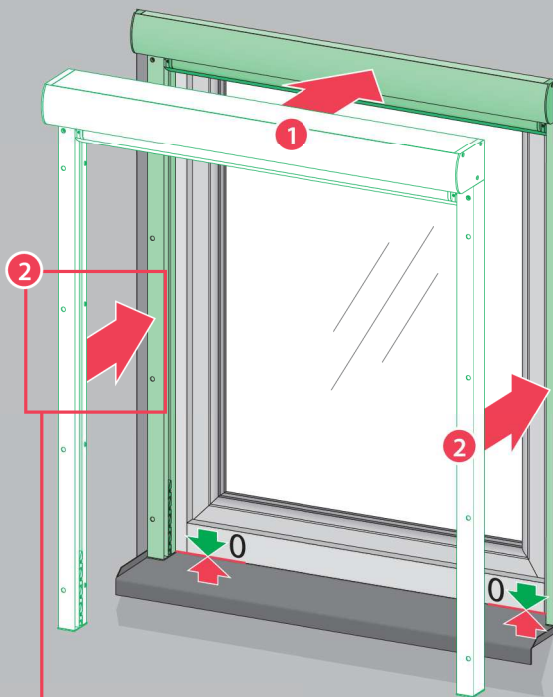

2b

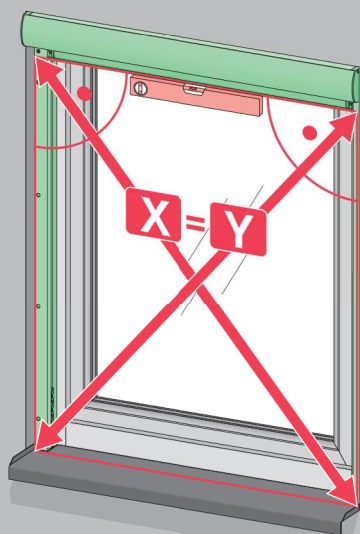

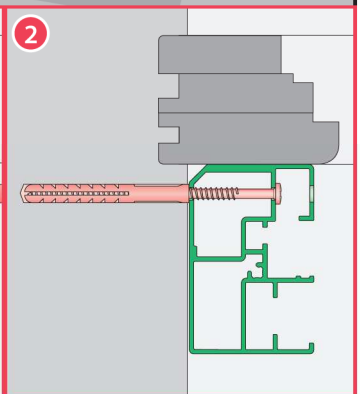
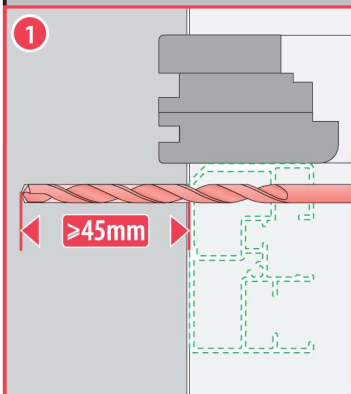
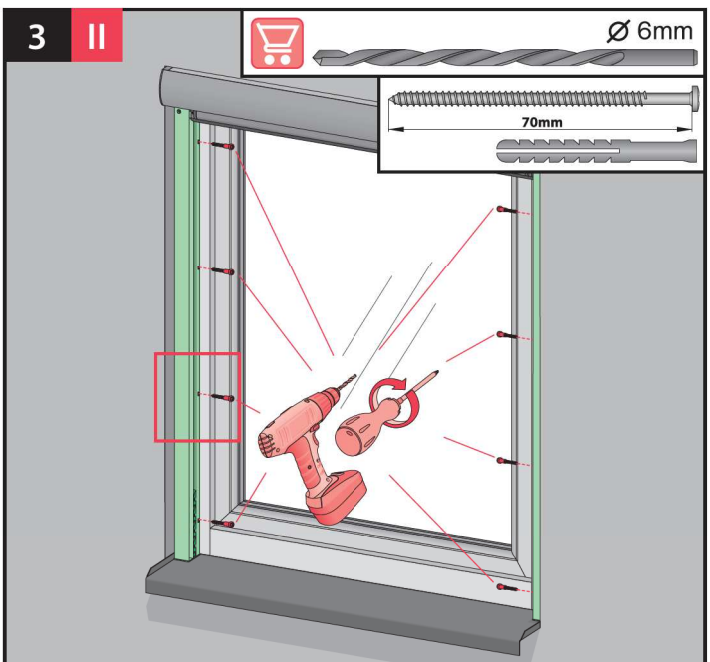
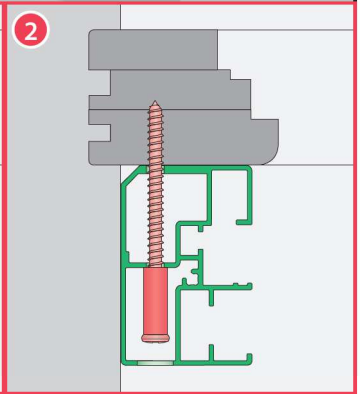
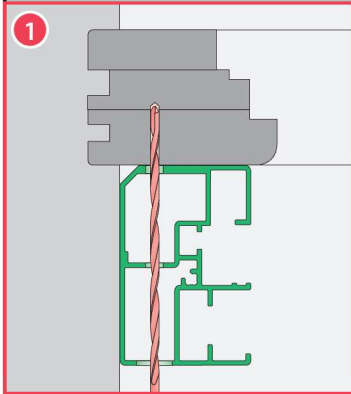
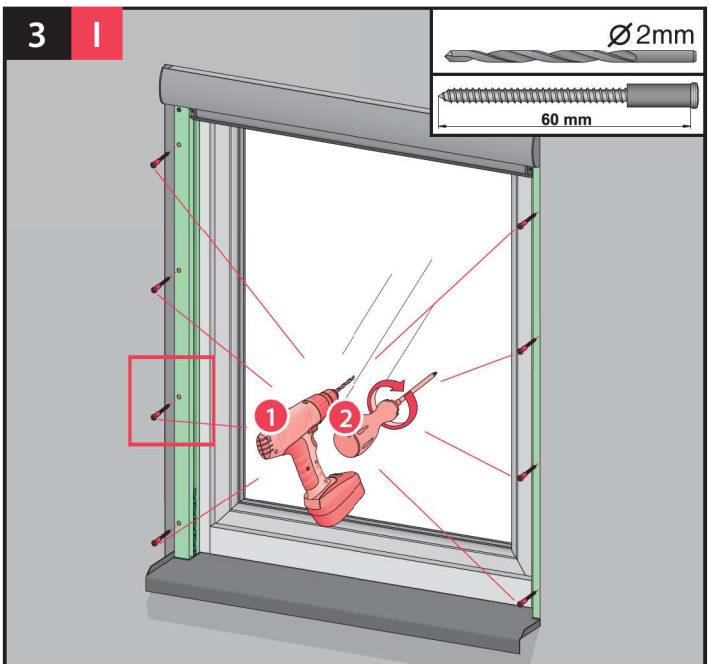

3

III

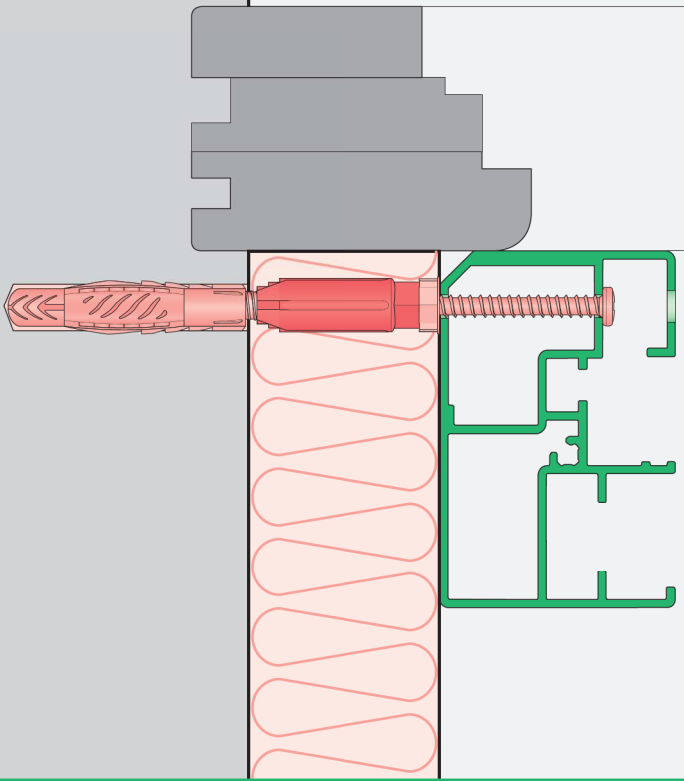

www.fakro.com/service

4

I

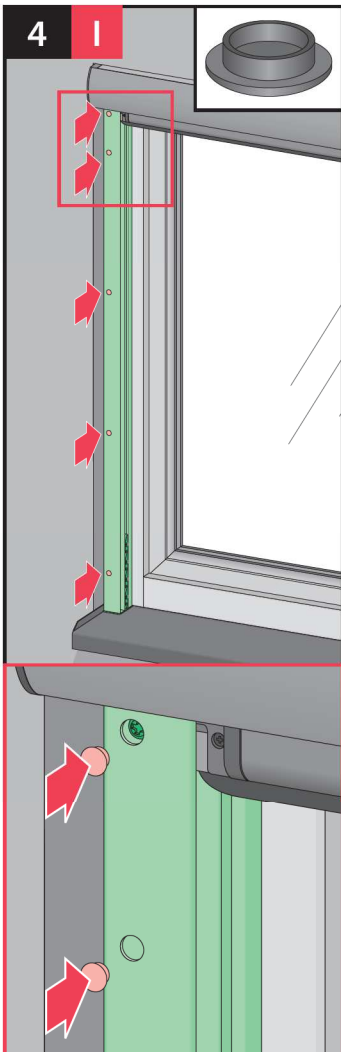

4

II

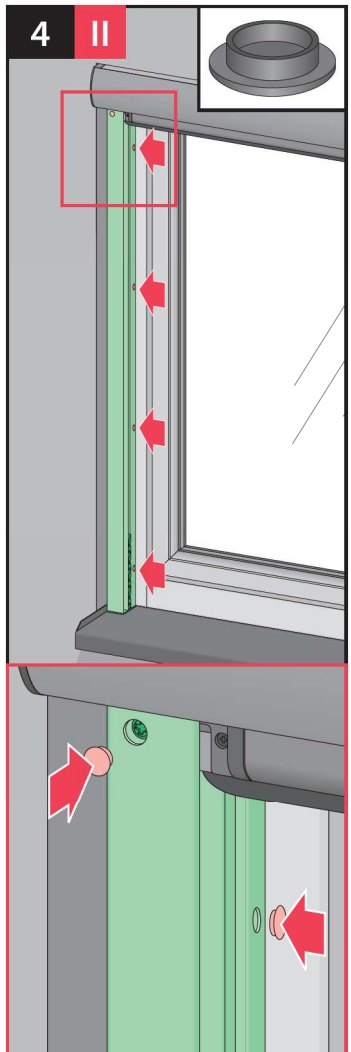

5

$L_1=R_1$

$L_2=R_2$

$L_3=R_3$

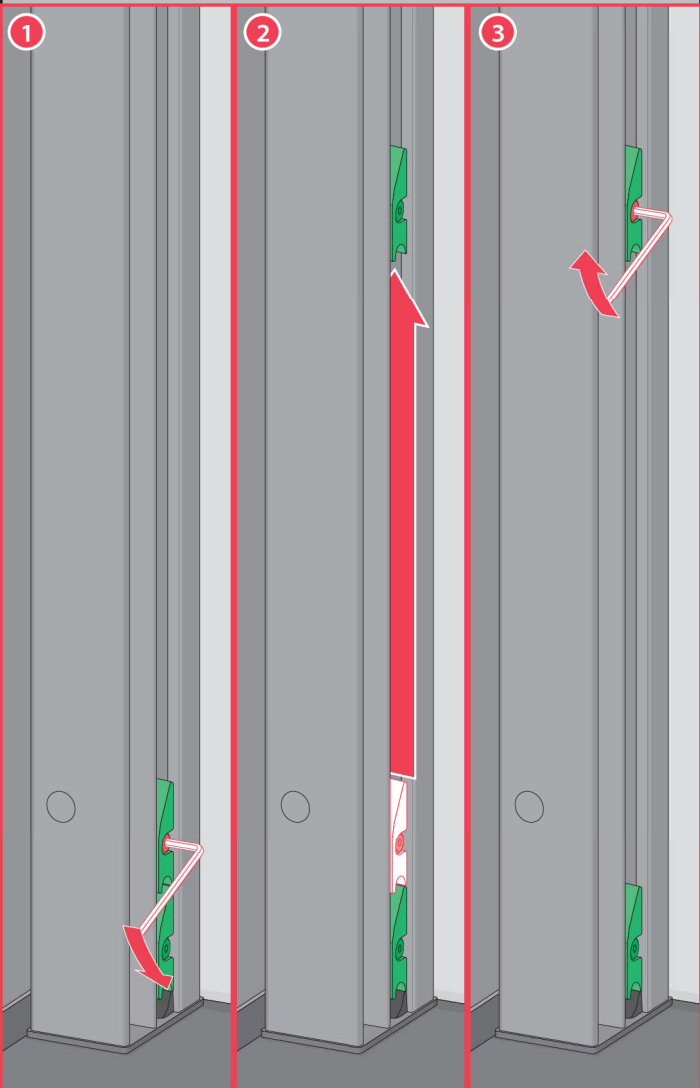
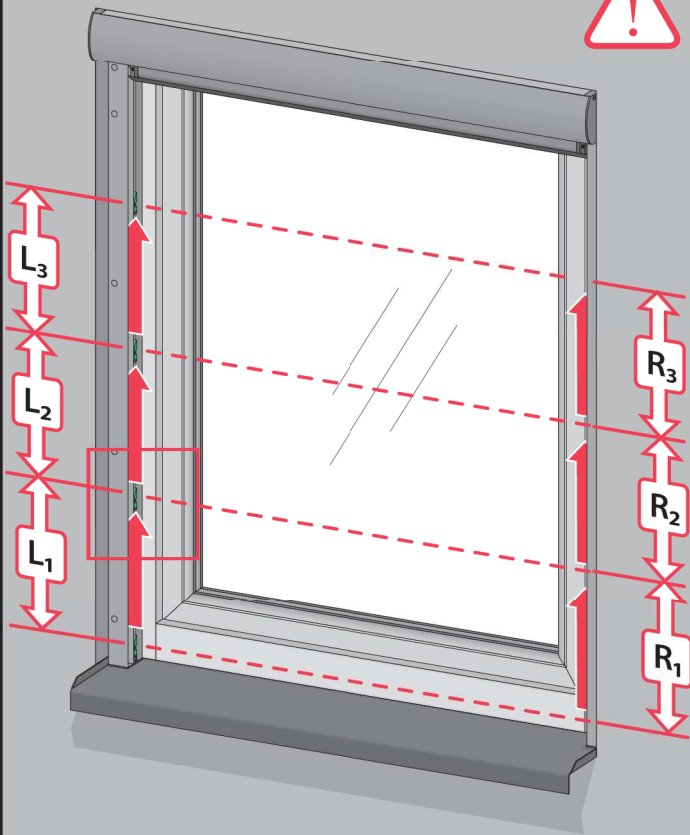

6

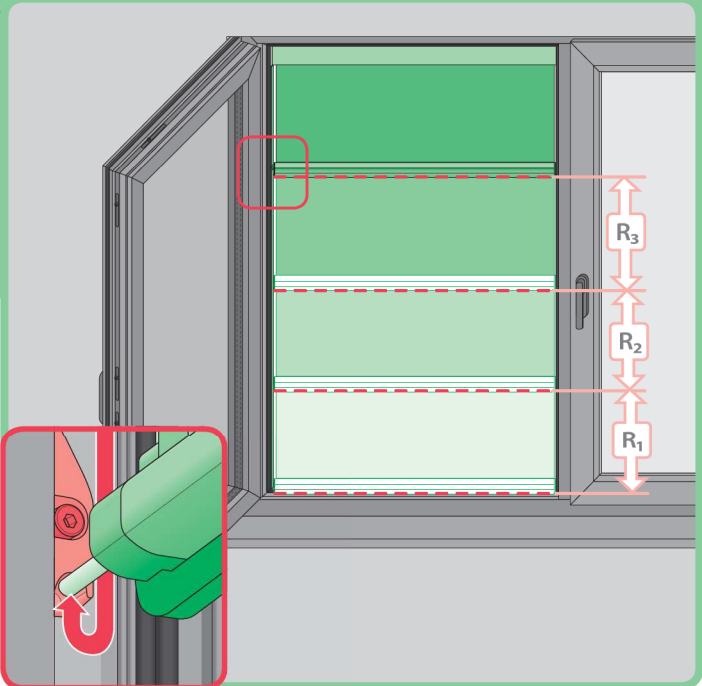
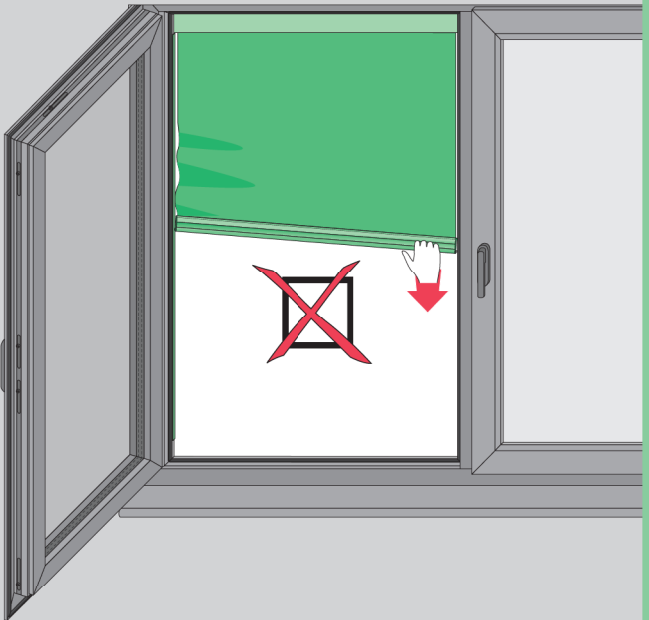
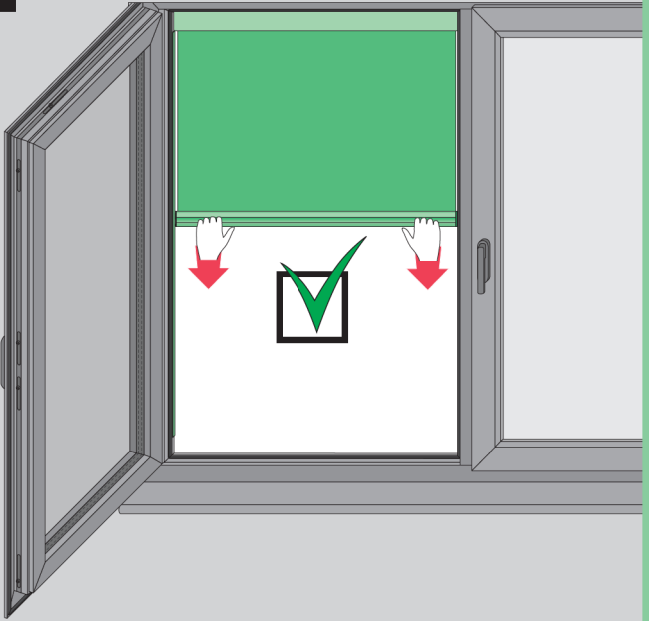

CZ	Před montáží si pozorně přečtěte návod NC9KC „ORIGINALNÍ NÁVOD 2/3 Pravidla pro instalaci a použití“.
1	Spojte boční vodičí lišty s kazetou markýzy.
2a	Umístěte markýzu do okenního otvoru.
2b	Zkontrolujte správnost montáže markýzy.
3	Přišroubujte markýzu k oknu nebo k ostění.
4	Vložte záslepky do otvorů vodičích lišt.
5	Nastavte polohu háčků ve vodičích lištách.
6	Markýzu ovládejte oběma rukama. Chcete-li markýzu zajistit v mezi-poloze, umístěte čepy do háčků vodičích lišt.

EN	Before installation, it is compulsory to read the NC9KC „ORIGINAL INSTRUCTIONS 2/3 Installation and user manual“.
1	Connect the side guide rails to the awning cassette.
2a	Place the awning in the window opening.
2b	Check the correctness of the awning installation.
3	Screw the awning to the window or to the lining.
4	Place plugs in the guide rails openings.
5	Determine the position of side catches in guide rails.
6	Operate the awning with both hands. To open the awning to intermediate positions, place the pin in the side catch of guide rails.

FR	Avant le montage, lire l'instruction NC9KC „INSTRUCTION ORIGINALE 2/3 Règles de montage et d'utilisation“.
1	Connectez les glissières latéraux à la cassette de store.
2a	Placez le store dans l'ouverture de la fenêtre.
2b	Vérifiez si le store est correctement installé.
3	Visser le store à la fenêtre ou à l'encadrement.
4	Placez les bouchons de fermeture dans les ouvertures des glissières.
5	Déterminez la position des loquets latéraux dans les glissières.
6	Faites fonctionner le store à deux mains. Afin d'ouvrir le store dans des positions intermédiaires, la goupille doit être placée dans le loquet latéral des glissières.

PL	Przed montażem należy zapoznać się z treścią instrukcji NC9KC „INSTRUKCJA ORYGINALNA 2/3 Zasady montażu i użytkowania“.
1	Połączyć prowadnice boczne z kasetą markizy.
2a	Umieścić markizę w otworze okiennym.
2b	Sprawdzić poprawność montażu markizy.
3	Przykręcić markizę do okna lub do szpalety.
4	Umieścić zaślepki w otworach prowadnic.
5	Ustalić położenie zaczepów bocznych w prowadnicach.
6	Obsługiwać markizę oburącz. W celu otwarcia markizy do pozycji pośrednich należy umieścić bolec w zaczepie bocznym prowadnic.

BG Производител и Продавец не носят отговорност за неспазване на съответните закони, строителни норми и изисквания за безопасност от потребителя на продукта, архитекта, монтажника или собственика на сградата.

CZ Výrobce ani prodejce nenesou žádnou odpovědnost za nedodržení příslušných platných zákonů, stavebních předpisů a bezpečnostních požadavků uživatelem výrobku, architektem, montážníkem nebo vlastníkem budovy.

DE Hersteller und Verkäufer übernehmen keine Haftung für Nichtbeachtung entsprechender Rechts- und Bauvorschriften sowie Sicherheitsanforderungen seitens Produktbenutzers, Architekten, Monteure oder Gebäudebesitzers.

ES El fabricante y el vendedor no tienen ninguna responsabilidad por el incumplimiento de la ley vigente, normas de construcción y exigencias de seguridad por parte del usuario del producto, arquitecto, instalador o el propietario del edificio.

FR Le fabricant et le revendeur ne prend aucune responsabilité de ne pas respecter les lois applicables, les règlements sur les bâtiments et les exigences de sécurité par l'utilisateur du produit, l'architecte, l'installateur ou le propriétaire du bâtiment.

GB Manufacturer and Seller shall bear no liability for failure to comply with the applicable laws, building codes and safety requirements by the user of the product, architect, fitter or owner of the building.

HU A Gyártó és a Forgalmazó nem vállal semmiféle felelősséget a vonatkozó törvényi, építési és biztonsági előírások termékfelhasználó, építész, beépítőmester vagy épülettulajdonos általi be nem tartásáért.

IT Il Produttore e il Rivenditore non potranno essere ritenuti responsabili per il mancato rispetto, da parte dell'utente del prodotto, del progettista, dell'installatore o del proprietario dell'edificio, delle leggi vigenti, nonché dei regolamenti edilizi e di quelli relativi alla sicurezza.

NL De fabrikant en verkoper zijn niet aansprakelijk voor gevolgen bij het niet opvolgen van toepasselijke wetten, bouwbesluiten en veiligheidsvoorschriften door de gebruiker van het product, de architect, de installateur of de eigenaar van het gebouw.

PL Producent i Sprzedawca nie ponosi żadnej odpowiedzialności za nieprzestrzeganie stosownych przepisów prawa, przepisów budowlanych i wymogów bezpieczeństwa przez użytkownika produktu, architekta, montażystę lub właściciela budynku.

PT O fabricante e o vendedor não tem nenhuma responsabilidade pelo o não cumprimento da lei, códigos de construção e as exigências de segurança por parte do usuário do produto, arquiteto, instalador ou proprietário do edifício.

RO Nici producătorul, nici distribuitorul nu își vor asuma niciun fel de răspundere pentru nerespectarea legilor în vigoare, a legilor din domeniul construcțiilor sau a măsurilor de siguranță impuse utilizatorilor produsului, arhitecților, montajorilor sau proprietarilor clădirii.

RU В случае несоблюдения архитектором, монтажником или владельцем здания строительных правил и норм безопасности ответственность с производителя и продавца снимается.

SK Výrobca a predajca nenesú žiadnu zodpovednosť za nedodržanie príslušných ustanovení zákona, stavebných predpisov a bezpečnostných požiadaviek užívateľom výrobku, architektom, montérom alebo majiteľom objektu.